



ops-core®

FAST®

FUTURE ASSAULT SHELL TECHNOLOGY

HELMET OPERATOR'S MANUAL

© OPS-CORE 2016 06-05-160 REV. B



**FOR FAST BALLISTIC
AND CARBON HELMETS**

HELMET VERSIONS

FAST HELMETS

This manual is specific to the following helmet models: FAST Ballistic High Cut, FAST Ballistic Maritime and FAST Carbon.

FAST Ballistic High Cut Helmet is used for reference drawings throughout this Operator's Manual. If there are any procedure discrepancies due to other helmet versions they will be specifically noted.

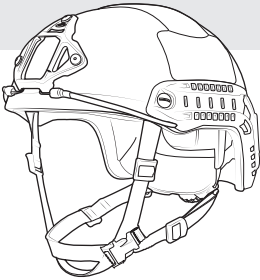

**FAST BALLISTIC
HIGH CUT**

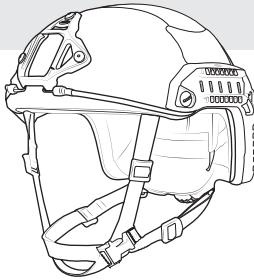

**FAST BALLISTIC
MARITIME**

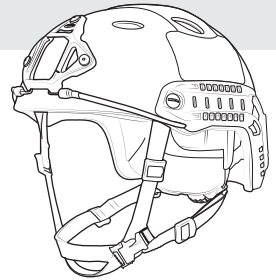

FAST CARBON

ALL HELMET VERSIONS INCLUDE:

(2) SIDE PADS, (2) 1/2" TOP PADS, (2) 3/4" TOP PADS, (1) 1/2" REAR PAD, (1) 3/4" REAR PAD



SIDE PAD



TOP PAD

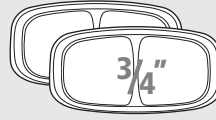

TOP PAD

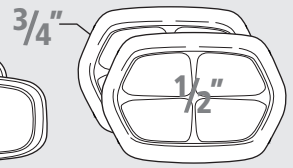

REAR PAD

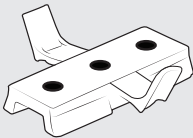

**WING-LOC
ADAPTER (1)**

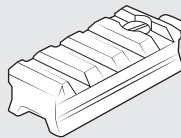

**PICATINNY
ADAPTER (1)**

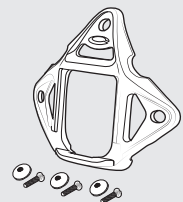

SKELETON SHROUD

TABLE OF CONTENTS

4	HELMET COMPONENTS
5	SIZING GUIDE
6-7	PRO SETUP
8	CHINSTRAP OPERATION
9-15	ACCESSORY INTEGRATION COUNTERWEIGHT & HELMET COVER SKELETON SHROUD FAST SIDE RAILS (ARCs) EXTERIOR VELCRO® SIDE COVERS & GUNSIGHT MANDIBLE COMMs HEADSET
16-22	MAINTENANCE SCHEDULE REPLACEMENT KITS REPLACEMENT FITBAND COMFORT PADS REPLACEMENT FITBAND & EPP PADS REPLACEMENT EXTERIOR VELCRO REPLACEMENT SKELETON SHROUD REPLACEMENT FAST SIDE RAILS
23-26	HELMET PART NUMBERS REPLACEMENT PARTS / ACCESSORIES PART NUMBERS
27	WARNING & WARRANTY
28	OPERATOR NOTES

HELMET COMPONENTS

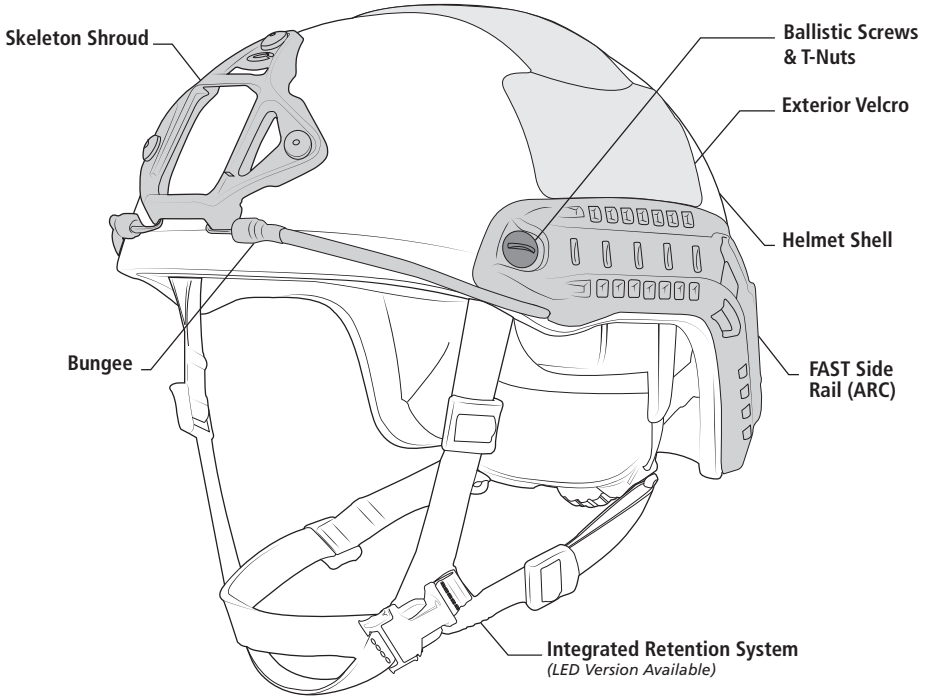

Note: LED = Left Eye Dominant

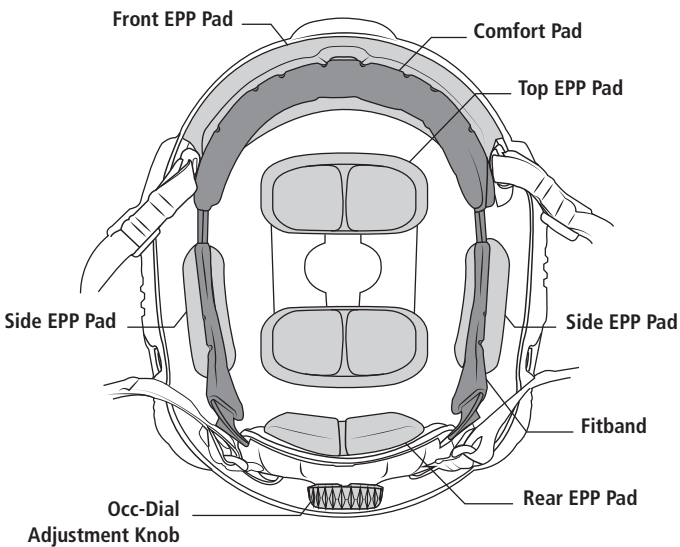

SIZING GUIDE

FAST helmets have been designed from the ground up to fit the largest group of users in helmet sizes that most closely match their heads. However, there is still a small percentage of users that will not fit our standard sizing configurations. Please use the sizing guide below to determine your helmet size and your chinstrap size. If you require a non-standard chinstrap/helmet configuration, custom solutions are available.

HELMET SIZING GUIDE

FAST HELMET SIZE	S/M	M/L	L/XL	XXL
Head Circumference (cm)	53 - 56	56 - 59	59 - 62	62 - 64.5
Head Circumference (in)	20% - 22	22 - 23¼	23¼ - 24¾	24¾ - 25¾
Head Size (US)	up to 7	up to 7¾	up to 7¾	up to 8¾

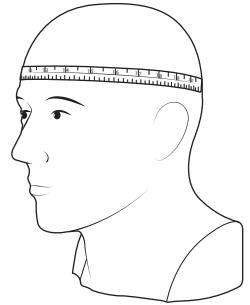

CHINSTRAP SIZING GUIDE

Since people have different shaped heads, helmet size (the size of the top of your head) is not always proportional to the chinstrap size (the size of your face).

FAST HELMET SIZE	CHINSTRAP SIZE (in)
S/M	MEDIUM 24.5-27.5
M/L	LARGE 26-29
L/XL	X-LARGE 27.5-30.5
XXL	X-LARGE 27.5-30.5

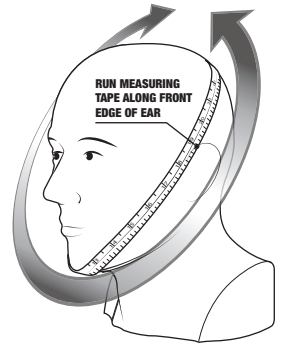

CUSTOM FIT COMBINATIONS

Your FAST Helmet can be custom fit with an alternate chinstrap size upon ordering or a replacement chinstrap can be purchased separately.

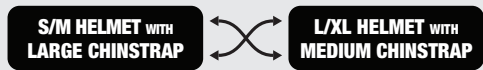

PRO SETUP

FAST Helmets were designed for professionals who expect the most from their equipment. Just like fine-tuning the suspension on a racecar or sighting in a fire-arm, the helmet must be set up properly before use to function correctly. If you do not follow these instructions, your helmet will not function in accordance with stated performance.

1 ADJUST THE TOP PADS

- Put the helmet on. 1/2" pads come pre-installed in the helmet. Turn the dial to loosen the fitband so that all of the helmet weight is resting on top of your head.
- With the fitband loose, check how high / low the helmet is sitting. Forehead pad should be above and not resting on the bony ridge of your eyebrows.

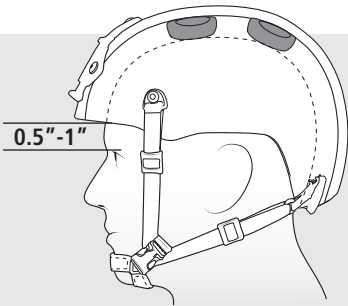
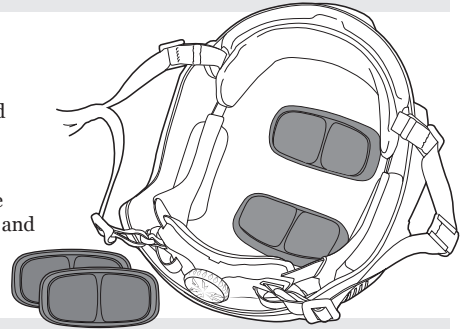

HEIGHT ADJUSTMENT

- The distance from the top of the eyebrow to the bottom of the fitband should be approximately 0.5" - 1". There should also be enough room around your ears for COMMs / hearing protection.
- If the helmet sits too low on your head, remove the 1/2" top pads and install the 3/4" top pads.
- If the helmet sits at an uncomfortable angle, adjust the top pads, or use a combination of 1/2" and 3/4" top pads until it sits correctly.

2 ADJUST THE REAR PADS

- Install the 3/4" rear pad. Put the helmet on.
- If you feel uncomfortable pressure on your forehead, take the 3/4" pad out and put in the 1/2" pad.
- If it feels the same as with the 1/2" pad (can't notice the difference) then keep the 3/4" installed. This will make the helmet more stable and comfortable.

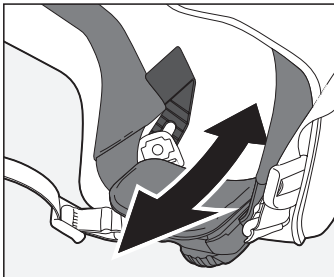
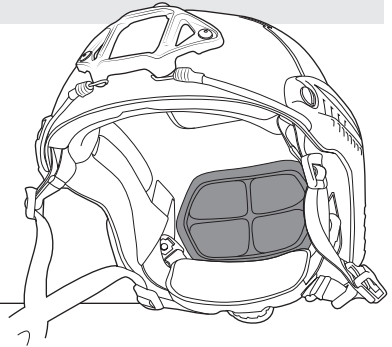

3 ADJUST FITBAND HEIGHT

- Put the helmet on and turn the dial to tighten the fitband until it feels secure. Look up at the sky. If the dial digs into your neck, it is too low.
- You can adjust the height of the dial by sliding the rear fitband liner tabs that attach it to the inside of the shell up and down.
- Set the dial at the height that is most comfortable for you.

4 "PRE-LOAD" THE FITBAND

- You can set the shape of the fitband to match the shape of your head for long term comfort.
- Push or pull the rear fitband liner tabs (used for height adjustment in step 3) to adjust the fitband tension from a round to more oval shape.
- Hold each rear fitband liner tab with your hand in the location that sets the fitband tension in the optimal shape and then tighten the back screws to lock the tabs in place.

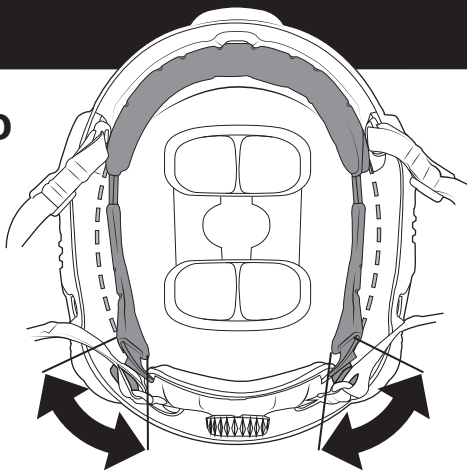

5 TIGHTEN BACK SCREWS

- Tighten the back screws to lock the rear fitband liner tabs, chinstrap and side rails permanently in place.
- If you don't do this, all of the adjustments you just made will slip and the helmet will likely come apart.

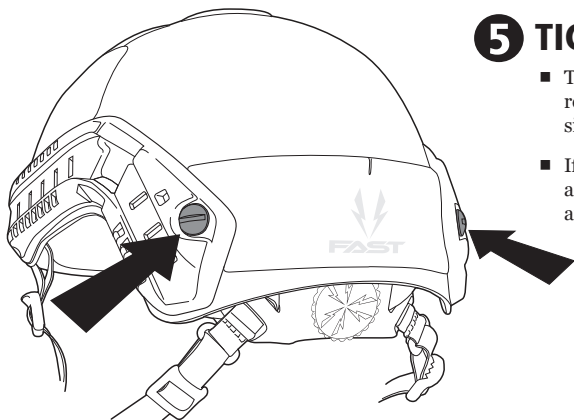

6 INSTALL THE SIDE PADS

- Install the side pads onto the Velcro patches on the inside of the helmet. These pads make the helmet more stable and increase protection from side impacts.
- If they feel tight or uncomfortable, try to relocate them into a position that feels good.

Note: Check that all screws and accessory hardware are tight and secure.

**YOUR HELMET IS
READY FOR USE!**

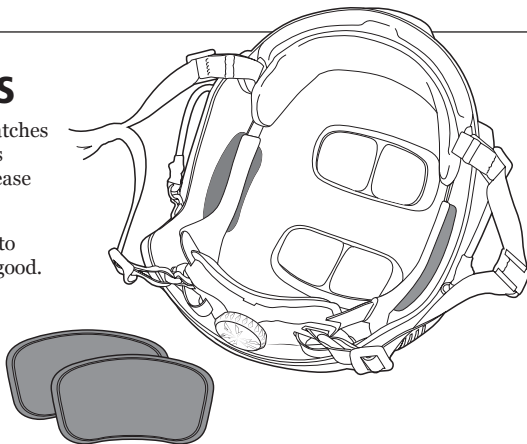

CHINSTRAP OPERATION

- 1** Put the helmet on and fasten the Chinstrap Buckle. Turn the Occ-Dial Adjustment Knob to tighten the fitband until it is comfortably snug.

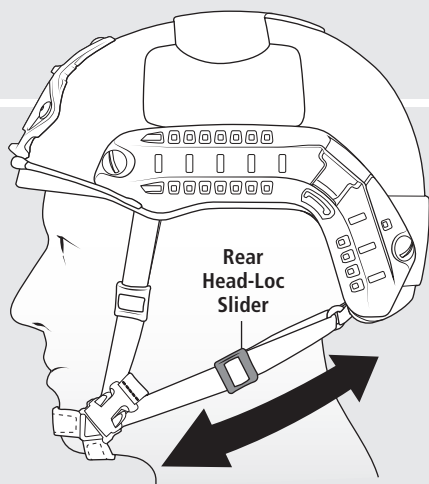
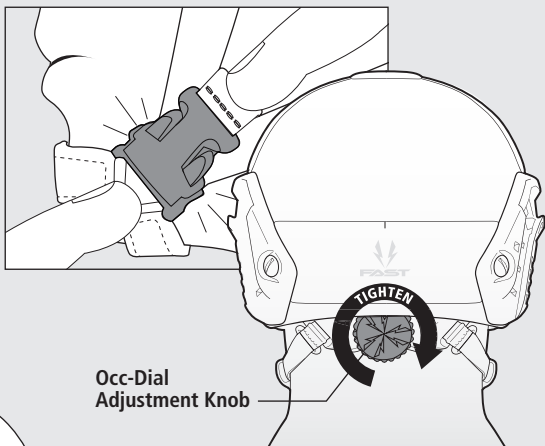

- 2** With both hands, pull the two Rear Head-Loc® Sliders on the lower webbing straps toward your chin until snug.

Note: The technique works best if you only hold the plastic sliders and don't touch the webbing.

- 3** With both hands, pull the two Front Head-Loc Sliders on the webbing straps that come from the front temples of the helmet toward your chin until snug.

Front Head-Loc Slider

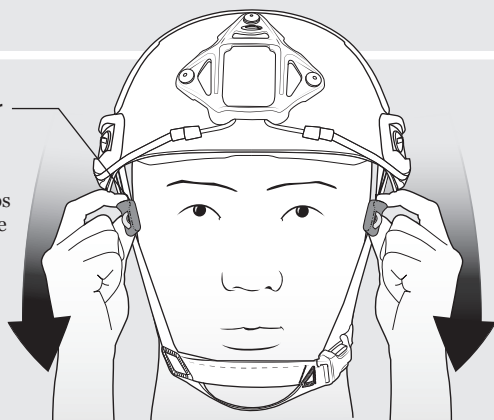

ACCESSORY INTEGRATION

There are three ways of attaching accessories to the FAST Helmet. The Ops-Core Skeleton Shroud or VAS Shroud, FAST Side Rails (ARCs), and Exterior Velcro. These three components provide convenient and secure ways to quickly attach and detach various accessories to different positions, and allow for personalized customization.

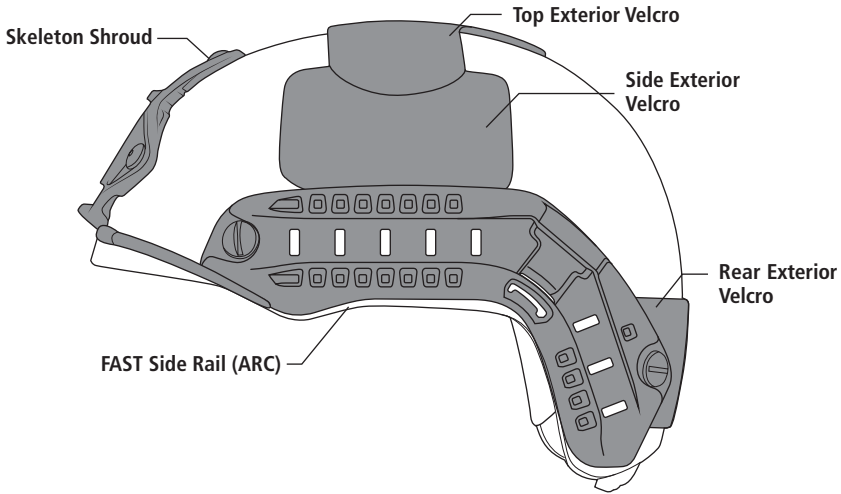

RECOMMENDED CONFIGURATIONS

There are numerous accessories that can be attached to your FAST Helmet to be used in a variety of situations. Below are some recommended configurations.

NIGHT OPERATIONS

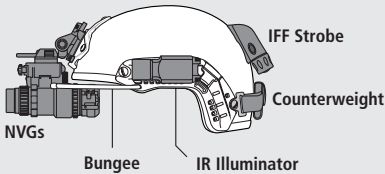

AIRBORNE OPERATIONS

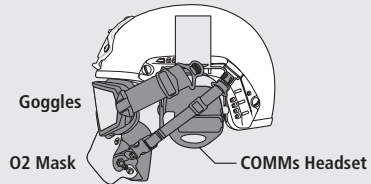

MISSION DOCUMENTATION

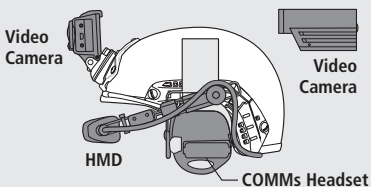

BREACHING / ATV

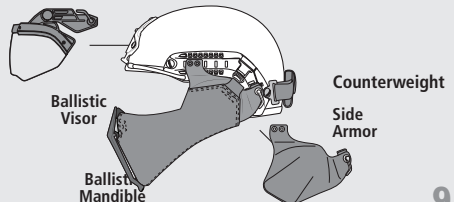

COUNTERWEIGHT & HELMET COVER

The Counterweight Kit reduces neck fatigue on long missions with night vision goggles or other accessories that add weight to the front of the helmet. The Helmet Cover provides a variety of camouflage options for different environments.

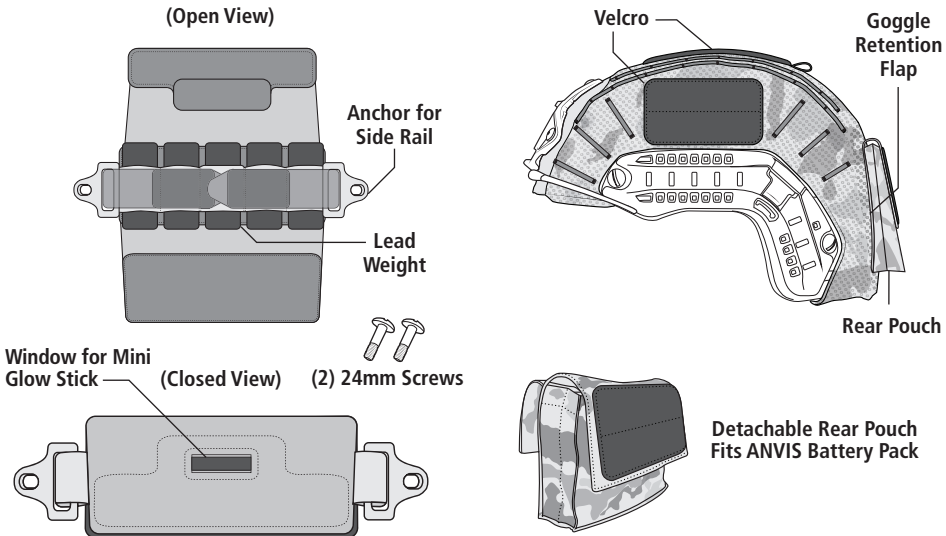

COUNTERWEIGHT KIT

The Counterweight Kit Includes (1) Counterweight Pack with (5) Lead Weights and (2) 24mm Screws.

HELMET COVER

The Helmet Cover protects the shell outer surface while still providing the functionalities of the FAST platform.

COUNTERWEIGHT ATTACHMENT

1 REMOVE REAR SCREWS

Remove screws and T-nuts at back of FAST Side Rails. Align the anchor of Counterweight to the holes on the rear of the FAST Side Rail. The Rear Exterior Velcro will hold Counterweight in place. Use your fingers to loosely attach a screw to the Counterweight and FAST Helmet. Be sure to place screw through Counterweight Anchor, Side Rail, Helmet Shell, Fitband and Chinstrap Anchor. Repeat for the opposite side.

2 SECURE COUNTERWEIGHT

Use a screwdriver to tighten all screws from the outside of the Counterweight, making sure the Counterweight is securely fastened to the rear of the FAST Helmet.

Note: Adding weight to helmet increases risk of neck strain and injury. Only add counterweight when absolutely necessary to balance loads on front of helmet.

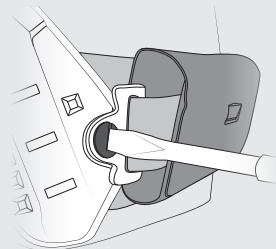
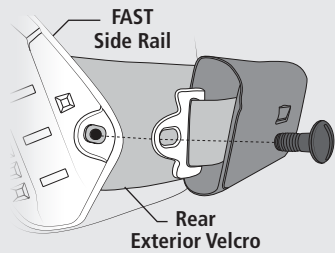

SKELETON SHROUD

The Skeleton Shroud provides a front mounting option for video cameras, visors, illuminators, and night vision goggles (NVG's).

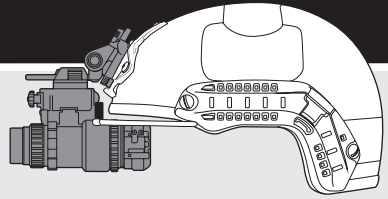

ATTACH NVG MOUNTING ARM

Insert and anchor the top of the NVG Mounting Arm underneath the top of the bracket as shown. While pressing the arm's release trigger, push down to snap and lock the arm in place.

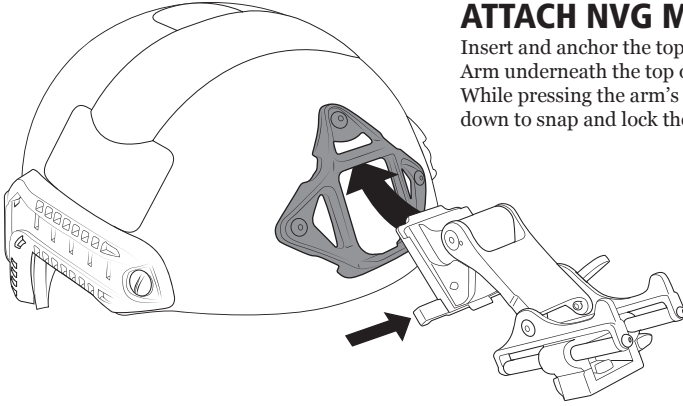

SKELETON SHROUD & VAS SHROUD COMPATIBILITY

Helmet Compatibility

Fits the standard MARSOC / WARCOC 3-hole NVG mount pattern

NVG & Mount Arm Compatibility

Ops-Core NVG Shrouds are compatible with the following combinations of night vision goggle and mount arm styles:

MOUNT ARM	US ARMY STANDARD #A3256368	WILCOX® L4 G21M #28300G21M	WILCOX® L4 G24 #28300G24	WILCOX® L4 G25 #28300G25	WILCOX® L4 G29M #28300G29M	WILCOX® L4 G01 #56500G01	WILCOX® L4 G02 #56500G02	NOROTOS® INVG #1820010	NOROTOS® AKA2 #1840010
NVG STYLE									
PVS-7B/7D	—			—					—
PVS-14	—		—	—					—
PVS-15			—	—				—	—
PVS-18			—	—				—	—
PVS-21		—							—
PVS-23						—			—
PVS-7A/7C				—					—
LUCIE NVG					—				
F5050						—			
F4949							—		
ANVS-6/9							—		

PULL TEST

Before attaching any NVG's to the mount, give it a sturdy tug in all directions to ensure it is properly secured.

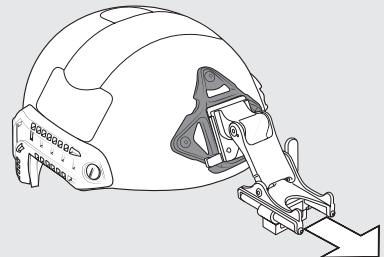

FAST SIDE RAILS (ARCs)

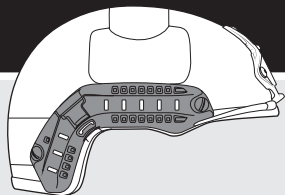

4-Position FAST Side Rails (ARCs) are mounted to the sides of the helmet to allow for quick yet secure donning or doffing of various headborne accessories.

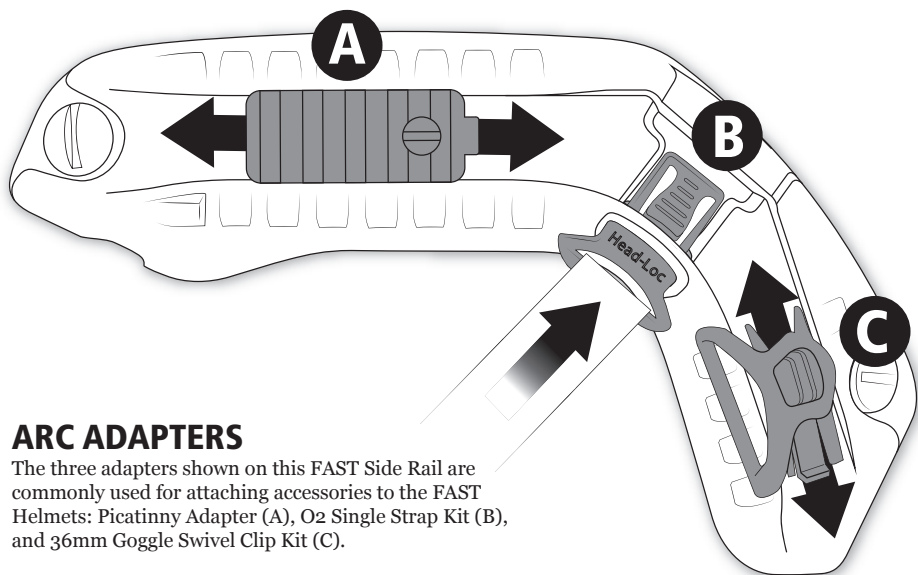

ARC ADAPTERS

The three adapters shown on this FAST Side Rail are commonly used for attaching accessories to the FAST Helmets: Picatinny Adapter (A), O2 Single Strap Kit (B), and 36mm Goggle Swivel Clip Kit (C).

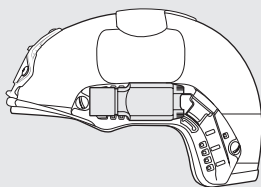

Picatinny Adapter
Wing-Loc Adapter

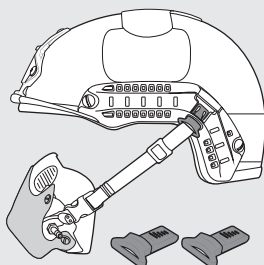

O2 Strap Kit

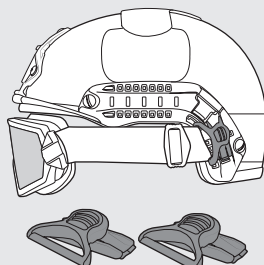

36mm Goggle Swivel Clips

A TOP RAIL

Top Rail can accommodate Picatinny Adapters, which connect devices compatible with 1911 Picatinny Rail, and Wing-Loc Adapters, which provide a base to mount a variety of headborne accessories.

B RAIL CORNER

Rail corner allows for instant and secure snap-in attachment of Para-Flite and Carleton O2 masks with O2 Single Strap Kit.

C BACK RAIL

Goggle Swivel Clips, attached to your choice of goggles, can quickly clip into the back rail while allowing freedom of rotation.

EXTERIOR VELCRO®

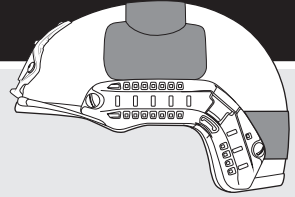

Exterior loop Velcro is attached at the top, sides, and rear of the FAST Helmet. The loop Velcro allows for easy mounting of accessories.

VELCRO ATTACHMENT

Apply hooked Velcro to the bottom of a device. Place device on top of the looped Velcro that is already attached to the FAST Helmet. Cover top of device with additional hook Velcro to secure it into place. Simply remove the device by pulling it away from the looped Velcro.

Note: Additional hook Velcro not included.

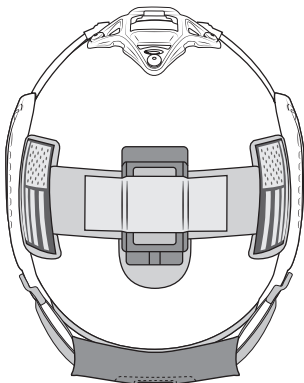
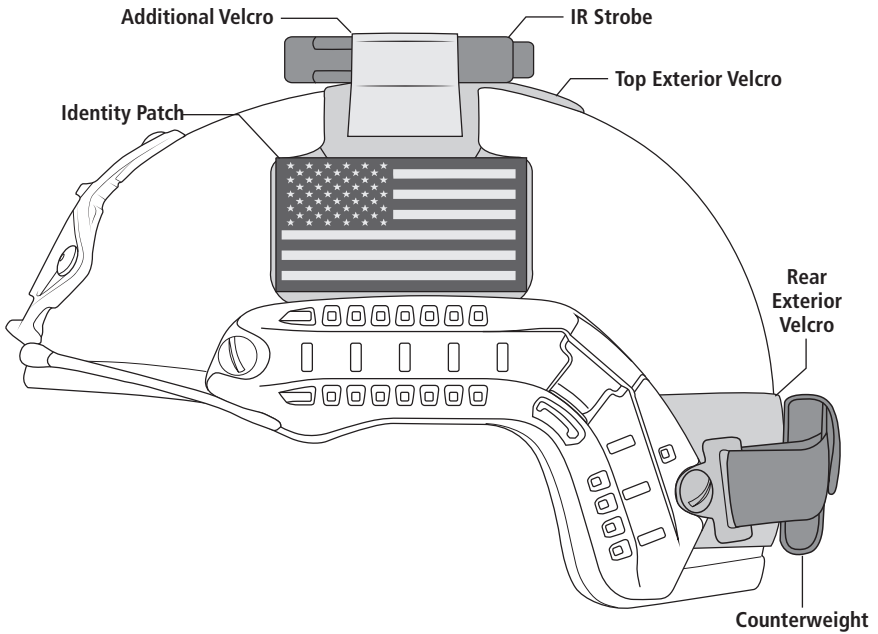

TOP VIEW

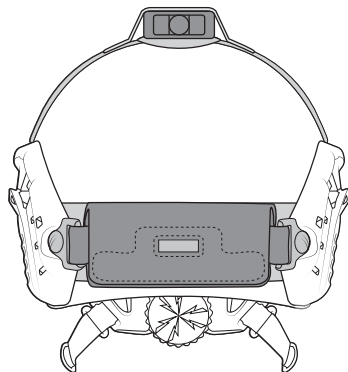

REAR VIEW

SIDE COVERS & GUNSIGHT MANDIBLE

The Up-Armor Side Covers and Gunsight Mandible are accessories that provide additional head coverage that allows a user to quickly adjust the degree of protection to match different threat levels.

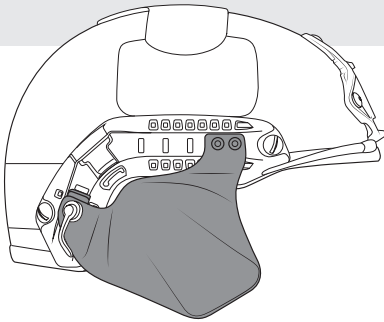

Edge Profile Clears
Rifle / Cheek Weld

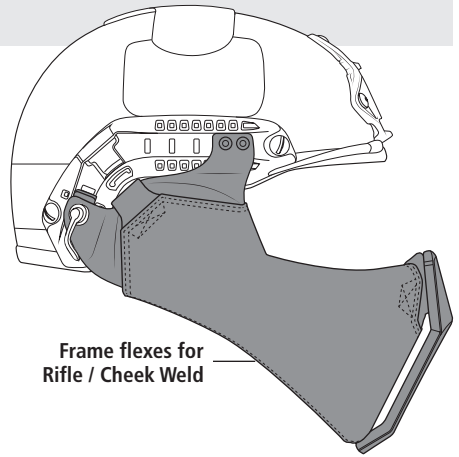

Frame flexes for
Rifle / Cheek Weld

UP-ARMOR SIDE COVERS

Up-Armor Side Covers are available in Ballistic and Non-Ballistic versions. Both versions feature a durable carbon fiber exterior. The Non-Ballistic version provides environmental protection, while the Ballistic version is made from the same type of materials as the FAST Ballistic helmet. *

GUNSIGHT MANDIBLE

The mandible uses a combination of soft armor and support frame technology to provide lower face protection. It is designed to fold in half to conveniently fit into a rucksack. The flexibility allows a close cheek weld and causes minimum interference with sighting shoulder weapons.

* Note: Detailed threat performance specifications are available at www.ops-core.com

ATTACHMENT

The Up-Armor Side Covers, and Mandible attach to the FAST Side Rails. Attachment is tool-less and takes less than a minute. Follow the Up-Armor Side Cover instructions below for attaching Mandible.

1 SLIDE FRONT SHOE IN PLACE

Slide the Front Shoe of the Side Cover into the front of the top FAST Side Rail (ARC) as shown.

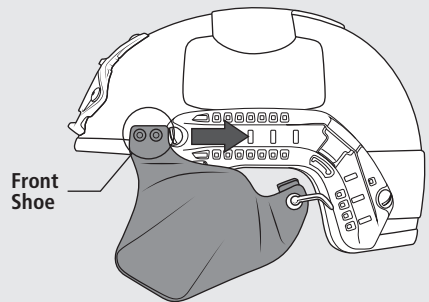

2 LOCK SIDE COVERS IN PLACE

Snap the back of the Side Cover into the rear FAST Side Rail (ARC) and turn the Cam-Loc Handle downward to lock into place.

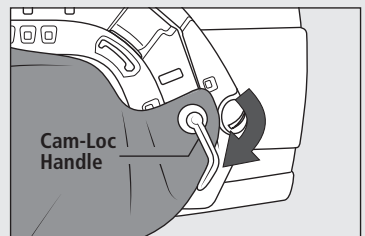

COMMs HEADSET

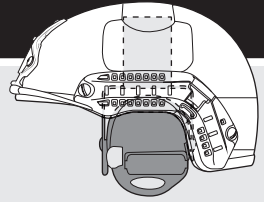

The liner system is compatible with a variety of COMMs headsets and hearing protection devices. Instructions for use with headband style COMMs is below.

1 RELOCATE TOP PADS

Position the top pads in the helmet so there is enough space for the headband of the headset to sit in between them.

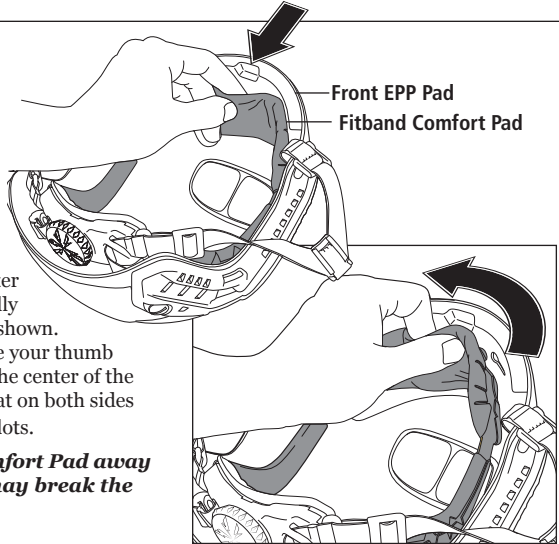
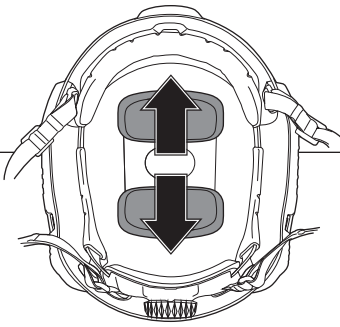

2 DETACH FITBAND

Place your index finger behind the center of the Fitband Comfort Pad and carefully bend away from the Front EPP Pad as shown. Pinch the Fitband Comfort Pad and use your thumb to slide the pad sideways $\frac{1}{2}$ " towards the center of the helmet along the Front EPP Pad. Repeat on both sides until the pad is released from the key slots.

Note: Do not pull the Fitband Comfort Pad away from the Front EPP Pad or you may break the Front EPP Pad Key Slots.

3 INSERT HEADSET HEADBAND

Flip the Comfort Pad / Fitband away from the front impact liner and slide the headset headband around it as shown. This will position the headset's headband on the outside of the helmet Fitband so that it does not create a pressure point when you tighten the Occ-Dial Adjustment Knob.

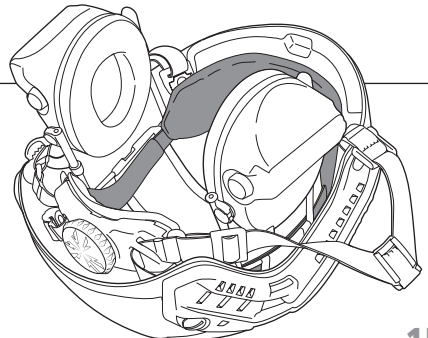
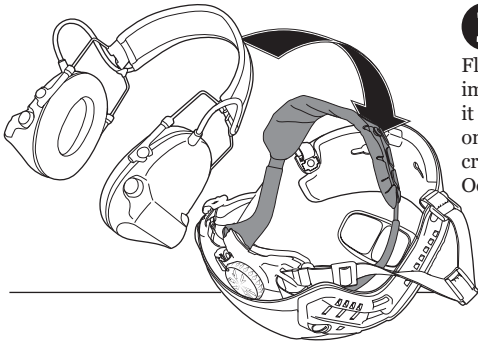

4 REATTACH FITBAND

Reattach the Comfort Pad / Fitband to the key-slots in the front impact liner by bending the pad in the center and pushing on the rivets (one at a time) with your thumb while at the same time sliding them toward the sides of the helmet.

MAINTENANCE SCHEDULE

RECOMMENDED MAINTENANCE: ALL USERS

- 1 Clean the helmet with a mild detergent and water.*
- 2 Check that the chinstrap screws are tight using a flathead screwdriver.
- 3 Clean the Velcro for dust and dirt by using air pressure.
- 4 Visually check the Skeleton Shroud or VAS Shroud and FAST Side Rails for signs of breakage.
- 5 Visually check the Fitband for signs of breakage.
- 6 Check that the Occ-Dial Adjustment Knob works properly.
- 7 Check that the chinstrap does not have any damage and that the buckle latches and releases properly.

**The whole helmet can be rinsed in fresh water.*

Note: If any defects are found, the damaged components should be replaced before use.

RECOMMENDED MAINTENANCE: ACTIVE DUTY

(Defined as soldiers who use their helmet 1440 hours/year or more)

- 1 Replace Fitband Comfort Pads every 100 days or once/year.
- 2 Replace Fitband, Chinstrap, Hardware, and EPP Pads after 2 years.
- 3 Replace Exterior Velcro and repaint shell after 4 years.
- 4 Replace other components if damaged / worn out as needed.

RECOMMENDED MAINTENANCE: NATIONAL GUARD

- 1 Replace all items on as-needed basis and based on inspection.
- 2 Replace Exterior Velcro and repaint the shell after 4 years.

REPLACEMENT KITS

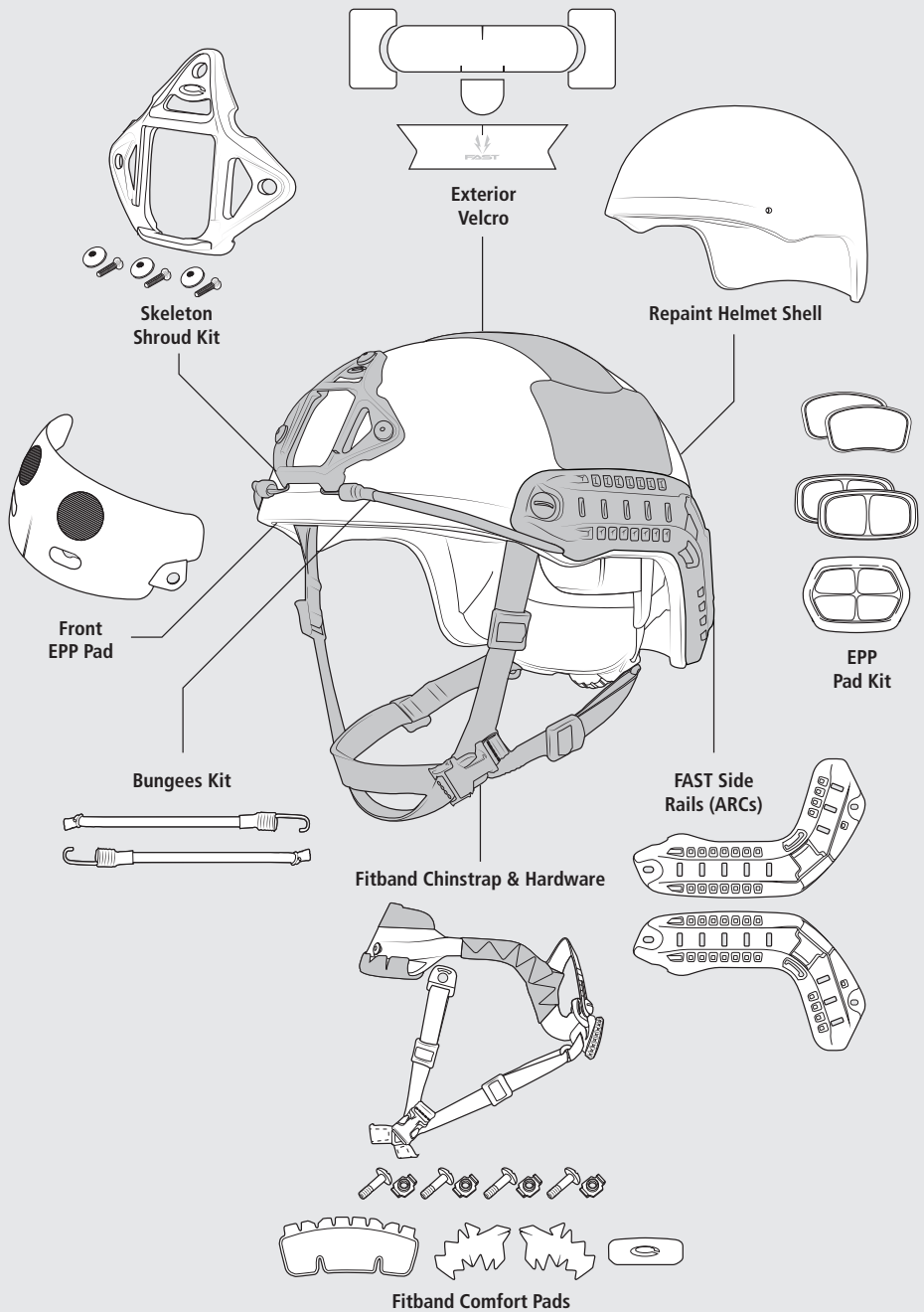

REPLACEMENT FITBAND COMFORT PADS

1 REMOVE OLD COMFORT PADS

Simply peel off all old comfort pads from the fitband. A fitband with all comfort pads removed should look like the image below.

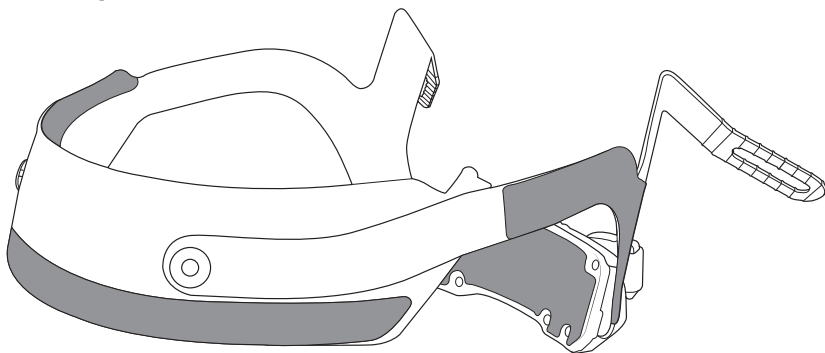

2 COMFORT PAD INSTALLATION

Attach the new comfort pads based on the instructions that came with the “Replacement Fitband Comfort Pads Installation Instructions” manual.

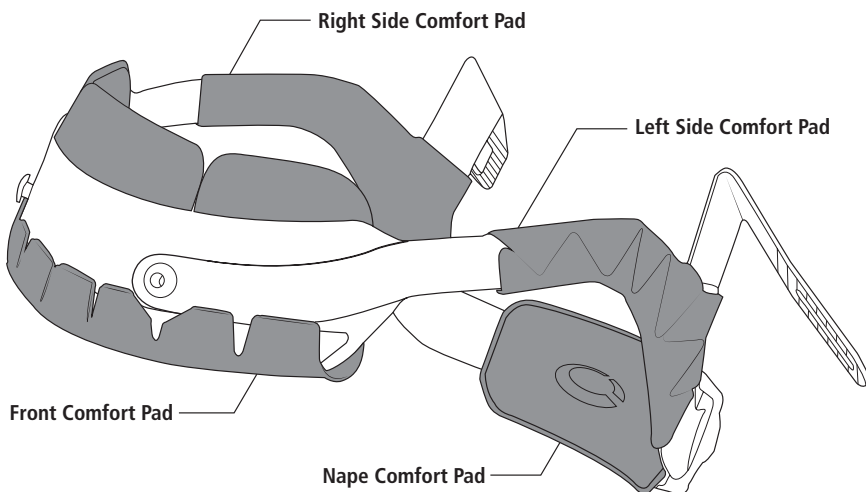

KIT INCLUDES THE FOLLOWING COMFORT PADS:

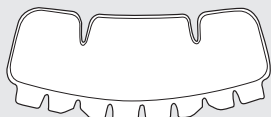

18

Front
Comfort Pad



Left Side
Comfort Pad



Right Side
Comfort Pad



Nape
Comfort Pad

REPLACEMENT FITBAND & EPP PADS

1 REPLACEMENT FRONT EPP PAD KIT:

The Front EPP Pad is inserted into the helmet shell before the Fitband. It is held into the helmet shell by Velcro patches.

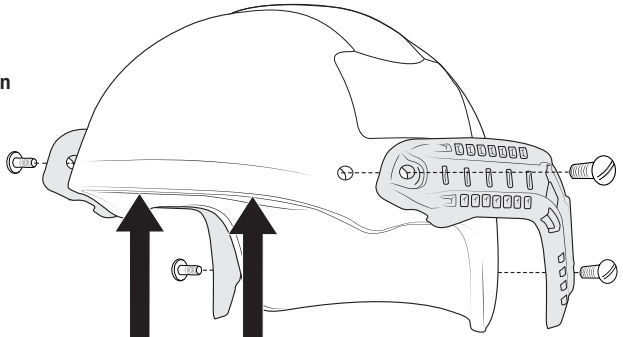
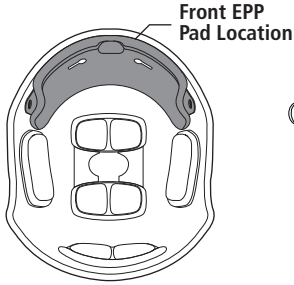

2 REPLACEMENT FITBAND:

The replacement Fitband kit attaches to the Front EPP Pad. Reassemble helmet as shown.

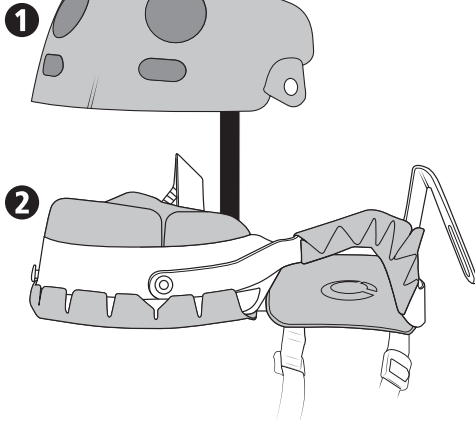
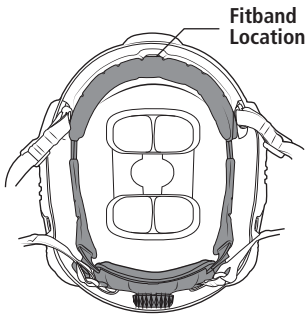

3 EPP PAD REPLACEMENT KIT

Install the pads onto the Velcro patches on the inside of the helmet as shown. The Top and Rear Pads come in two different thicknesses. Use the pad that fits the best. See pages 6-7.

KIT INCLUDES THE FOLLOWING EPP PADS:

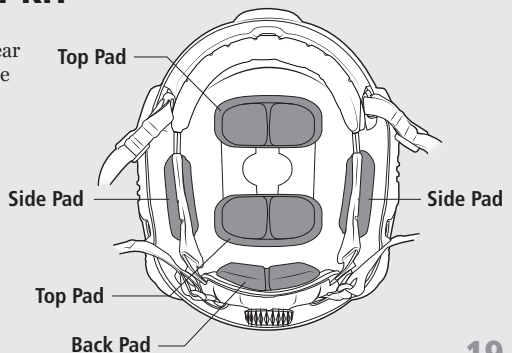
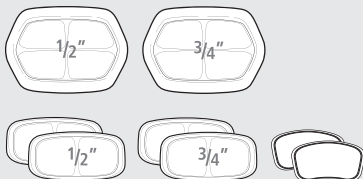

REPLACEMENT EXTERIOR VELCRO

1 CAREFULLY REMOVE OLD VELCRO

Note: It may be easier to remove Velcro by heating the helmet shell to 70°C using a hair dryer. Do not heat helmet above 70°C or helmet will be seriously damaged.

Using your fingers, carefully peel the Velcro away from the helmet shell. **DO NOT BRISKLY RIP THE VELCRO OFF!** Continue this process by slowly pulling it back until all Velcro is removed.

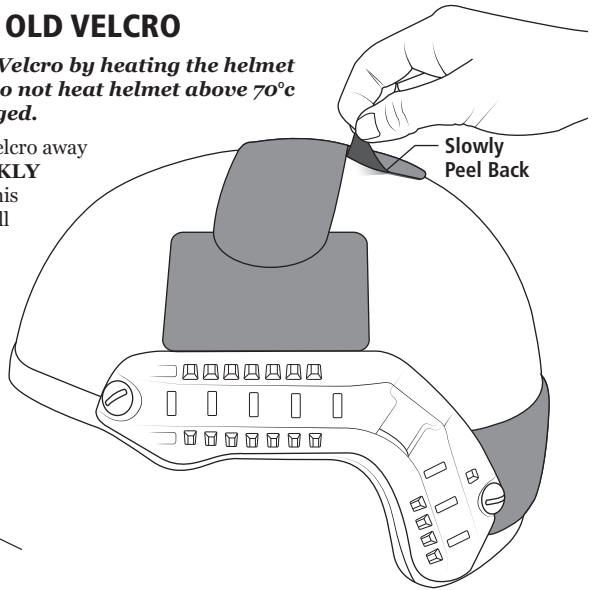
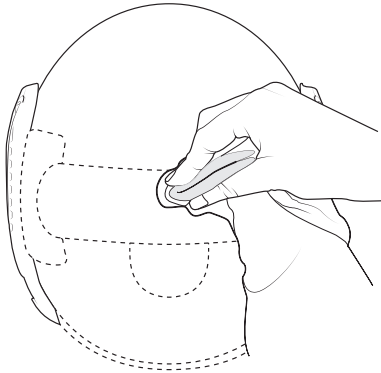

2 CLEAN THE HELMET SHELL

To remove excess adhesive from old Velcro and to ensure optimal adhesion of new Velcro, gently rub affected areas with a clean towel and Isopropyl Rubbing Alcohol. Do not use harsh chemicals. If traces of adhesive remain, you can use Goo Gone® to remove stubborn residue. Wipe the area with alcohol again after use. Allow the helmet to dry before attempting to place new Velcro onto the shell's surface.

3 PLACEMENT PREPARATION

Using the diagram to the right, carefully align Velcro pieces to their proper positions. Test fit all pieces before removing backing. Adhesive on this Velcro is pressure sensitive. Once in place it needs to be pressed down firmly. Please allow up to 24 hours for adhesive to reach maximum bonding strength.

KITS INCLUDE THE FOLLOWING REPLACEMENT PARTS:

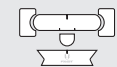

FAST High Cut



Kit A
FAST Maritime



Kit B



FAST Carbon

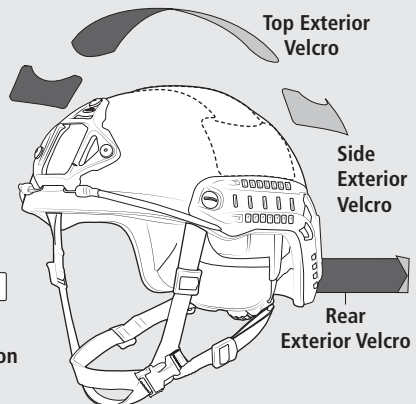

REPLACEMENT SHROUD

Before replacing Skeleton Shroud or VAS Shroud, the helmet's Fitband and Front EPP Pad must be removed.

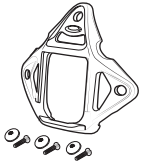

Replacement kit includes
(1) Skeleton Shroud, (3)
Screws and (3) T-nuts.

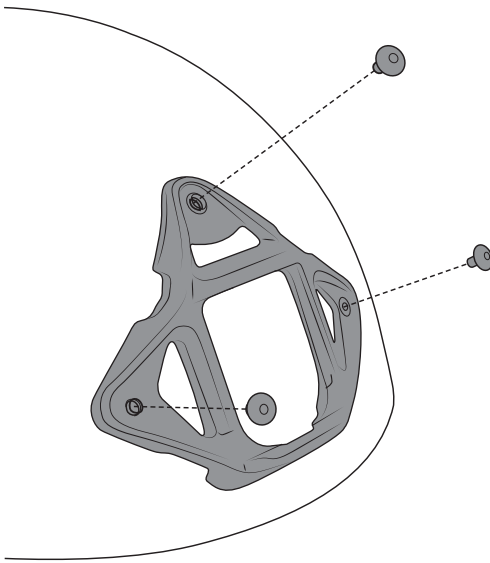
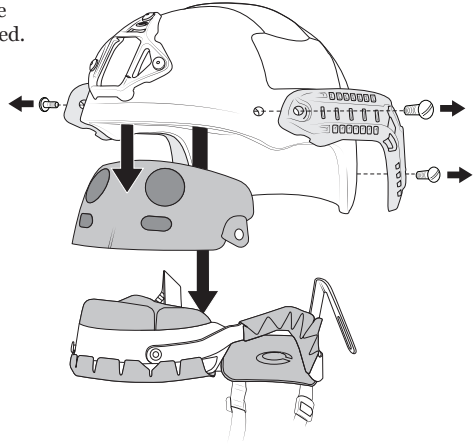

Align the Skeleton Shroud or VAS Shroud with the existing 3-hole pattern on the front of your helmet. Insert a T-nut through the Shroud's top hole from the front (outside) of the helmet shell and use your fingers to loosely attach a screw from the inside of helmet shell. Repeat for remaining 2 holes.

Finish by using a screwdriver to tighten all 3 screws from the inside of shell, making sure the Shroud is securely fastened to the helmet.

Note: Tighten screws by hand until secured. Do not over tighten, this will cause deformation to helmet shell and compromise helmet's ballistic capabilities.

BUMPER INSTALLATION

The optional foam backer is included to stick on the back of the mount arm plate. This backer can reduce wiggle or vibration between the shroud, mount arm, and helmet.

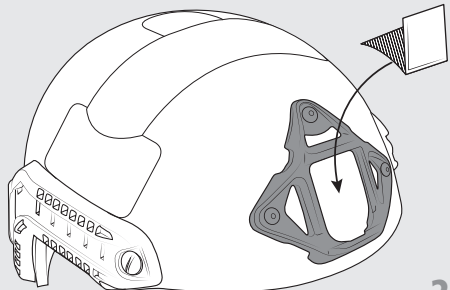

REPLACEMENT FAST SIDE RAILS

Align the new FAST Side Rails with the existing Chinstrap Holes on your FAST helmet. Loosely assemble the FAST Side Rails, Helmet Chinstrap Anchors, and new hardware by following the diagram below. For the rear assembly be sure to include the Rear Fitband Tab as shown. Repeat for opposite side of helmet. Once all components are loosely assembled, finish by using a screwdriver to tighten the two front screws. Leave rear screws loose before executing instructions on pages 6-7.

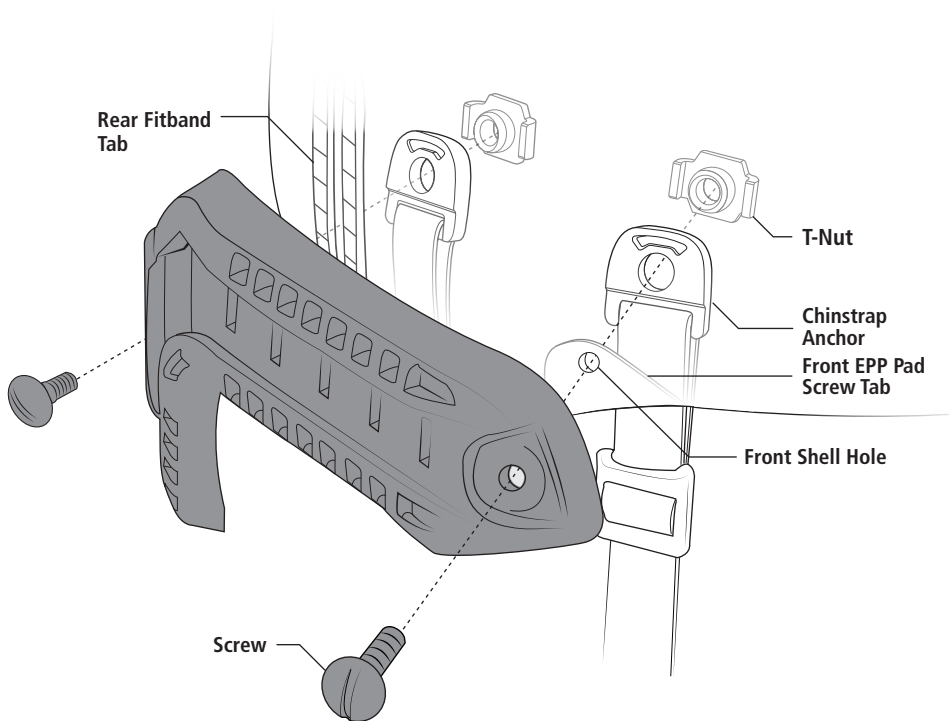

BUNGEE INSTALLATION

Insert the bungee ends into the FAST Side Rail's Bungee Retention Slot before assembly.

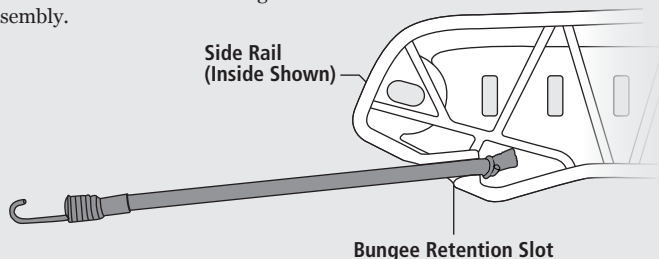

HELMET PART NUMBERS

FAST BALLISTIC HIGH CUT HELMET

Note: LED = Left Eye Dominant

FAST BALLISTIC HIGH CUT (NO SHROUD)	S/M	M/L	L/XL	XXL
TAN	69-99-121	69-99-141	69-99-151	69-99-181
GREEN	69-99-122	69-99-142	69-99-152	69-99-182
BLACK	69-99-123	69-99-143	69-99-153	69-99-183
MULTICAM	69-99-129	69-99-149	69-99-159	69-99-189
DESERT MARPAT	69-99-128	69-99-148	69-99-158	69-99-188
FAST BALLISTIC HIGH CUT (W/ MOUNTED SHROUD)	S/M	M/L	L/XL	XXL
TAN	69-99-221	69-99-241	69-99-251	69-99-281
GREEN	69-99-222	69-99-242	69-99-252	69-99-282
BLACK	69-99-223	69-99-243	69-99-253	69-99-283
MULTICAM	69-99-229	69-99-249	69-99-259	69-99-289
DESERT MARPAT	69-99-228	69-99-248	69-99-258	69-99-288
FAST BALLISTIC HIGH CUT (LED NO SHROUD)	S/M	M/L	L/XL	XXL
TAN	69-99-321	69-99-341	69-99-351	69-99-381
GREEN	69-99-322	69-99-342	69-99-352	69-99-382
BLACK	69-99-323	69-99-343	69-99-353	69-99-383
MULTICAM	69-99-329	69-99-349	69-99-359	69-99-389
DESERT MARPAT	69-99-328	69-99-348	69-99-358	69-99-388
FAST BALLISTIC HIGH CUT (LED W/ MOUNTED SHROUD)	S/M	M/L	L/XL	XXL
TAN	69-99-421	69-99-441	69-99-451	69-99-481
GREEN	69-99-422	69-99-442	69-99-452	69-99-482
BLACK	69-99-423	69-99-443	69-99-453	69-99-483
MULTICAM	69-99-429	69-99-449	69-99-459	69-99-489
DESERT MARPAT	69-99-428	69-99-448	69-99-458	69-99-488

FAST BALLISTIC MARITIME HELMET

FAST BALLISTIC MARITIME (NO SHROUD)	S/M	M/L	L/XL
TAN	72-99-121	72-99-141	72-99-151
MULTICAM	72-99-129	72-99-149	72-99-159
FAST BALLISTIC MARITIME (W/ MOUNTED SHROUD)	S/M	M/L	L/XL
TAN	72-99-221	72-99-241	72-99-251
MULTICAM	72-99-229	72-99-249	72-99-259
FAST BALLISTIC MARITIME (LED NO SHROUD)	S/M	M/L	L/XL
TAN	72-99-521	72-99-541	72-99-551
MULTICAM	72-99-529	72-99-549	72-99-559
FAST BALLISTIC MARITIME (LED W/ MOUNTED SHROUD)	S/M	M/L	L/XL
TAN	72-99-621	72-99-641	72-99-651
MULTICAM	72-99-629	72-99-649	72-99-659

FAST CARBON HELMET

FAST CARBON (NO SHROUD)	S/M	M/L	L/XL
TAN	59-99-121	59-99-141	59-99-151
GREEN	59-99-122	59-99-142	59-99-152
BLACK	59-99-123	59-99-143	59-99-153
MULTICAM	59-99-129	59-99-149	59-99-159
DESERT MARPAT	59-99-128	59-99-148	59-99-158

HELMET PART NUMBERS (CONTINUED)

FAST CARBON HELMET (CONTINUED)

FAST CARBON (W/ MOUNTED SHROUD)	S/M	M/L	L/XL
TAN	59-99-221	59-99-241	59-99-251
GREEN	59-99-222	59-99-242	59-99-252
BLACK	59-99-223	59-99-243	59-99-253
MULTICAM	59-99-229	59-99-249	59-99-259
DESERT MARPAT	59-99-228	59-99-248	59-99-258
FAST CARBON (LED NO SHROUD)	S/M	M/L	L/XL
TAN	59-99-321	59-99-341	59-99-351
GREEN	59-99-322	59-99-342	59-99-352
BLACK	59-99-323	59-99-343	59-99-353
MULTICAM	59-99-329	59-99-349	59-99-359
DESERT MARPAT	59-99-328	59-99-348	59-99-358
FAST CARBON (LED W/ MOUNTED SHROUD)	S/M	M/L	L/XL
TAN	59-99-421	59-99-441	59-99-451
GREEN	59-99-422	59-99-442	59-99-452
BLACK	59-99-423	59-99-443	59-99-453
MULTICAM	59-99-429	59-99-449	59-99-459
DESERT MARPAT	59-99-428	59-99-448	59-99-458

REPLACEMENT / ACCESSORIES

FAST BALLISTIC REPLACEMENT PARTS

REPLACEMENT FITBAND, CHINSTRAP & HARDWARE	S/M	M/L	L/XL	XXL
TAN	60-99-121	60-99-141	60-99-151	60-99-181
GREEN	60-99-122	60-99-142	60-99-152	60-99-182
BLACK	60-99-123	60-99-143	60-99-153	60-99-183
REPLACEMENT FITBAND, CHINSTRAP & HARDWARE (LED)	S/M	M/L	L/XL	XXL
TAN	60-99-221	60-99-241	60-99-251	60-99-281
GREEN	60-99-222	60-99-242	60-99-252	60-99-282
BLACK	60-99-223	60-99-243	60-99-253	60-99-283
REPLACEMENT EXTERIOR VELCRO	S/M	M/L	L/XL	XXL
TAN	60-96-121	60-96-141	60-96-151	60-96-181
GREEN	60-96-122	60-96-142	60-96-152	60-96-182
BLACK	60-96-123	60-96-143	60-96-153	60-96-183
REPLACEMENT FAST SIDE RAILS (ARCS) W/ BUNGEE	S/M	M/L	L/XL	XXL
TAN	29-99-121	29-99-141	29-99-151	29-99-181
GREEN	29-99-122	29-99-142	29-99-152	29-99-182
BLACK	29-99-123	29-99-143	29-99-153	29-99-183
REPLACEMENT FAST SIDE RAILS (ARCS) NO BUNGEE	PART #	VAS SHROUD REPLACEMENT HARDWARE		PART #
TAN	29-99-201	TAN		35-98-101
GREEN	29-99-202	GREEN		35-98-102
BLACK	29-99-203	BLACK		35-98-103
REPLACEMENT BALLISTIC HARDWARE KIT 22MM	PART #			PART #
(1) Pack = (4) 22mm Screws + (4) T-Nuts	03-98-103	Bulk Pack = (100) 22mm Screws + (100) T-Nuts		03-98-203
REPLACEMENT FAST BALLISTIC BUNGEEES	S/M	M/L	L/XL	
TAN	29-98-121	29-98-141	29-98-151	
GREEN	29-98-122	29-98-142	29-98-152	
BLACK	29-98-123	29-98-143	29-98-153	

REPLACEMENT / ACCESSORIES

FAST MARITIME REPLACEMENT PARTS

REPLACEMENT EXTERIOR VELCRO	S/M	M/L	L/XL
TAN KIT A	60-96-421	60-96-441	60-96-451
TAN KIT B	60-96-521	60-96-541	60-96-551
REPLACEMENT FAST SIDE RAILS (ARCs) W/ BUNGEE	S/M	M/L	L/XL
TAN	29-99-521	29-99-541	29-99-551
REPLACEMENT FAST SIDE RAILS (ARCs) NO BUNGEE	PART #		
TAN	29-99-601		

FAST CARBON REPLACEMENT PARTS

REPLACEMENT FITBAND, CHINSTRAP & HARDWARE	S/M	M/L	L/XL
TAN	60-95-121	60-95-141	60-95-151
GREEN	60-95-122	60-95-142	60-95-152
BLACK	60-95-123	60-95-143	60-95-153
REPLACEMENT FITBAND, CHINSTRAP & HARDWARE (LED)	S/M	M/L	L/XL
TAN	60-95-221	60-95-241	60-95-251
GREEN	60-95-222	60-95-242	60-95-252
BLACK	60-95-223	60-95-243	60-95-253
REPLACEMENT EXTERIOR VELCRO	S/M	M/L	L/XL
TAN	60-96-221	60-96-241	60-96-251
GREEN	60-96-222	60-96-242	60-96-252
BLACK	60-96-223	60-96-243	60-96-253
REPLACEMENT FAST SIDE RAILS (ARCs) WITH BUNGEE	S/M	M/L	L/XL
TAN	29-99-221	29-99-241	29-99-251
GREEN	29-99-222	29-99-242	29-99-252
BLACK	29-99-223	29-99-243	29-99-253
REPLACEMENT FAST SIDE RAILS (ARCs) NO BUNGEE	PART #	VAS SHROUD REPLACEMENT HARDWARE	PART #
TAN	29-99-301	TAN	35-96-101
GREEN	29-99-302	GREEN	35-96-102
BLACK	29-99-303	BLACK	35-96-103
REPLACEMENT BALLISTIC HARDWARE KIT 15MM	PART #		PART #
(1) Pack = (4) 15mm Screws + (4) T-Nuts	03-99-103	Bulk Pack = (100) 15mm Screws + (100) T-Nuts	03-99-203
REPLACEMENT FAST CARBON BUNGEEES	S/M	M/L	L/XL
TAN	29-98-221	29-98-241	29-98-251
GREEN	29-98-222	29-98-242	29-98-252
BLACK	29-98-223	29-98-243	29-98-253

FAST BALLISTIC & CARBON REPLACEMENT PARTS

REPLACEMENT FRONT EPP PAD	PART #		
S/M	60-98-123		
M/L	60-98-143		
L/XL	60-98-153		
XXL	60-98-183		
REPLACEMENT EPP PAD KIT	PART #		PART #
S/M & M/L (8 pads total, no front pad)	60-98-203	L/XL (8 pads total, no front pad)	60-98-303
REPLACEMENT FITBAND COMFORT PADS	PART #		
Black (4 pads total)	60-97-003		

REPLACEMENT / ACCESSORIES (CONTINUED)

FAST ACCESSORIES

ADAPTERS		PART #	ADAPTERS		PART #
Picatiny Adapter		20-99-103	19mm Swivel Clips & Shoes (2 per set)		20-95-203
Wing-Loc Adapter		20-98-103	36mm Swivel Clips & Shoes (2 per set)		20-95-103
Single Clamp		20-97-103	Contour HD Adapter		20-94-103
X300 Adapter		20-96-103			
O2 DOUBLE STRAP KIT		PART #	UP-ARMOR SIDE COVERS BALLISTIC		PART #
TAN		26-99-101	TAN		37-99-101
GREEN		26-99-102	GREEN		37-99-102
BLACK		26-99-103	BLACK		37-99-103
O2 SINGLE STRAP KIT		PART #	UP-ARMOR SIDE COVERS NON-BALLISTIC		PART #
TAN		26-99-301	TAN		37-99-201
GREEN		26-99-302	GREEN		37-99-202
BLACK		26-99-303	BLACK		37-99-203
SKELETON SHROUD FAST BALLISTIC					PART #
TAN					XX-XX-XXX
GREEN					XX-XX-XXX
BLACK					XX-XX-XXX
VAS SHROUD FAST BALLISTIC (HB26)		PART #	CBRN MASK EXTENDER		PART #
TAN		35-99-201	TAN		19-99-101
GREEN		35-99-202	GREEN		19-99-102
BLACK		35-99-203	BLACK		19-99-103
VAS SHROUD FAST CARBON		PART #	GUNSIGHT MANDIBLE		PART #
TAN		35-99-401	TAN		38-99-101
GREEN		35-99-402	GREEN		38-99-102
BLACK		35-99-403	BLACK		38-99-103
COUNTERWEIGHT KIT		PART #	MULTICAM		PART #
TAN		39-99-101	MULTICAM		38-99-109
			MULTICAM		39-99-109
FLEECE CHINCUP/ EXTENDER COVER		PART #			
BLACK		19-99-203			
MESH HELMET COVER FOR FAST HIGH CUT		PART #	MESH HELMET COVER FOR FAST MARITIME		PART #
S/M MULTICAM		41-98-229	S/M MULTICAM		41-98-129
M/L MULTICAM		41-98-249	M/L MULTICAM		41-98-149
L/XL MULTICAM		41-98-259	L/XL MULTICAM		41-98-159
HELMET BAG					PART #
M/L BLACK					XX-XX-XXX
L/XL BLACK					XX-XX-XXX

! WARNING



DOES NOT PROTECT
against 7.62 and
5.56 rounds



NOT INTENDED
for motor
vehicle use



DOES NOT PROTECT
from extreme
hazards

This helmet provides LIMITED protection for the head and does not offer any protection against neck, spinal, or certain types of brain injuries including those caused by rotational forces. Some hazards can exceed this helmet's ability to provide protection and could cause severe head, brain, or spinal injuries including paralysis or death.

Remember: the higher the impact velocity, the greater the chance of injury / death. Common sense is the best defense.

SAFETY CHECKLIST:

Inspect the helmet before each use. Make sure the shell, liner pads, plastic hardware, stitching, chinstrap, and fit system components are not damaged, cracked, deformed, loose or showing signs of excessive wear. Do not remove or alter the front, top, or back impact pads. Do not apply paint, solvents, or like products as they could degrade helmet integrity and resulting performance. Replace your helmet if it is subjected to a significant impact since the shell and/or liner pads could be damaged without showing any obvious signs of a problem.

These instructions must be followed by all persons using or maintaining this helmet in order for it to perform as designed. Failure to do so could result in equipment malfunction, serious injury or death.

WARRANTY

The FAST helmet shell is warranted for (5) years from date of purchase against material defects and/or faulty workmanship.

All other liner components including the Worm-Dial, head-band, pads, and chinstrap retention system are warranted for (1) year from date of purchase against material defects and/or faulty workmanship.

This warranty is in lieu of all other warranties, expressed, implied, or statutory, and is strictly limited to the terms hereof: Ops-Core specifically disclaims any warranty of merchantability or of usefulness for a particular purpose.

The defective product must be returned to Ops-Core with proof of purchase and information describing the nature of the problem.

It is expressly agreed that the Purchaser's sole and exclusive remedy for breach of the above warranty, for any tortious conduct of Ops-Core, or for any other cause of action, shall be the repair, replacement, or credit, at Ops-Core's discretion, of any components or parts thereof, that after examination by Ops-Core are proven to be defective.

If it is determined by Ops-Core that the product's failure was due to accident, abuse, misuse, neglect, improper maintenance, or normal wear and tear, the product is not covered in this warranty.

Ops-Core shall be released from all obligations under this warranty in the event repairs or modifications are made to any of the parts by persons other than its own service personnel.

No agent, employee or representative of Ops-Core may bind Ops-Core to any affirmation, representation or modification of the warranty concerning the goods sold under this contract.

Exclusion of Consequential Damages – Purchaser specifically understands and agrees that under no circumstances will Ops-Core be liable to Purchaser for economic, special, incidental, or consequential damages or losses of any kind whatsoever, including but not limited to, loss of anticipated profits and any other loss caused by reason of non-operation of the goods. This exclusion is applicable to claims for breach of warranty, tortious conduct or any other cause of action against Ops-Core.

